

SNOM D785

Next Generation VoIP







The Snom D785 belongs to the latest generation of advanced Snom IP phones. Elegantly designed (Black and white) and featuring a large high-resolution colour display and a convenient second screen for dynamic contact management as well as integrated Bluetooth, this IP phone has all the functions necessary to fulfil even the most demanding requirements. Featuring an integrated Digital Signal Processor (DSP), the Snom D785 has unprecedented HD audio quality. Based on 20 years of experience in audio engineering, Snom provides the best sound quality for every application.





The timeless, modern design of the Snom D785, combined with a large high-resolution colour display is perfect for any working day. The newly designed user interface and second screen make using this telephone more intuitive than ever. Thanks to the second integrated display many applications can be managed quickly and easily.

The D785 allows you to set up 24 one-touch keys to manage group calls and speed dial/function keys by displaying all information dynamically.

The Snom D785 is the perfect combination of advanced technology and elegant design and sets new standards with its intuitive user interface. Due to its high-resolution colour display and practical second screen, the D785 marks another milestone in the twenty-year history of the VoIP phone pioneer, Snom.



	Navigation key	
		<ul style="list-style-type: none"> On idle screen: Press to select identity for outgoing calls In other contexts: Moving up and down lists one item/button at a time
		<ul style="list-style-type: none"> On idle screen, press to open list of received calls. In text fields, press to move the cursor to the left one character at a time.
		<ul style="list-style-type: none"> On idle screen, press to open the list of missed calls and simultaneously turn off the missed call LED In text fields, press to move the cursor to the right one character at a time.
	<ul style="list-style-type: none"> On idle screen: Redial (view list of dialed calls). Press to accept calls on speakerphone and in headset mode. Press to confirm actions/settings and return to preceding screen. 	
	<ul style="list-style-type: none"> Press to terminate calls on speakerphone and in headset and handset modes. Press to cancel actions and return to preceding screen. 	

	Page toggle key for the function key screen (second screen). Press the left or right rim of the key to put the next "page" of four key label "pages" on screen.
	Message key. The LED of the key is lit when a new message is waiting on the mailbox. Press the key to retrieve messages.
	Phone directory.
	Settings menu.
	Transfer.







	Hold key.
	<p>Turn "do not disturb" (DND) mode on and off for all identities registered on the phone (Fig. 1). If you want to turn on DND for one or more, but not all of the identities (Fig. 2), use the Configuration identity settings on the phone's web user interface. In DND mode incoming calls do not ring; callers hear the busy signal.</p> <p>Exception: Phone numbers on your directory's VIP list</p> <p>When DND is on, you'll see the DND symbol on the display.</p>



Fig.1 - DND active



Fig. 2 - DND active for one of the configured identities

	<p>Press the right or left edge of the key to adjust the volume</p> <ul style="list-style-type: none"> • of the ringer when the phone is idle or ringing • of the loudspeaker in handset, casing, or headset, respectively, when in call
	<p>Muting and unmuting the microphone</p>
	<ul style="list-style-type: none"> • Toggling between handsfree and handset mode • Dialing numbers on speakerphone • Accepting calls on speakersphone
	<p>Toggling between headset and handset modes.</p> <p>Note: Handset mode overrides headset mode. When the handset is picked up, the headset symbol in the status line will be replaced by the handset symbol, indicating that you can now use only the handset for the call. To return audio to the headset, press  again. The headset symbol will reappear in the status line. You can then place the handset in the cradle without ending the call.</p>

In order to access the desk phone and its features, please make sure that the desk phone is provisioned to the users account or organisation as a free seating phone. When provisioned, the user has to be logged in order to access the phones features. Shortcut and quick dial keys are assigned in the user's Self-service portal. Please note that your locally installed configurations will be overwritten after every reboot.

Calling and answering users are managed similarly on all Snom devices. There are five distinctive ways of calling and two ways of answering the phone.

To call:

- Dial the number using the numpad and press ✓.
- Press any preassigned **shortcut key**.
- Press and hold any quick **dial key**.
- Select a contact in your contact list and press ✓.
- Search for any contact in the directory and press ✓.

To answer:

Either lift the handset or press ✓ to answer via speaker or headset.

To check for missed calls:

- Press **Call History**.
- Navigate and select Missed Calls.
- Check the missed calls on the display.

To do attended transfer:

- When making a call, press **Hold**, the call is now put on hold.
- Press the number to the third party, please press ✓ to proceed.
- When the call is answered, you may speak to the third party, please press **Transfer** followed by ✓ to proceed.

To do blind transfer:

- When making a call, press **Transfer**.
- Press the number to the third party, please hang up to proceed.

To make conference call:

- When making a call, press **Hold**, the call is now put on hold
- Press the number to the third party, please press ✓ and wait for member to answer.
- Press button configured as conference.

To change presence:

- Navigate to the Presence Menu through the Settings Menu, please note that the current presence is shown on the display.
- Select preferred presence and press ✓.

Setting up your device

DHCP corresponds to a Dynamic Host Configuration Protocol, i.e. a network management protocol used on IP networks. The DHCP server automatically assigns configurations to each device on the network, i.e. all devices are communicating via the ISP. When the Snom device is connected to the network, it will automatically begin to initialize by connecting to the DHCP and download the configurations. Please note that this moment is the most problematic, troubleshooting usually begins here.

Headsets

The RJ audio jack corresponds to the media inputting source, i.e. connecting a headset or an EHS (Electronic Hook Switch) box. If you want to use a wired headset, please insert the headset cable in the RJ outlet. If you want to use a wireless headset, please interconnect your wireless headset and EHS box to the RJ audio source jack.

Power and internet

Please make sure that your device is connected to a power outlet. In some infrastructures there are PoE (Power over Ethernet) outlets, enabling power sourcing through the ethernet cable. If no PoE opportunities exists, then connect your device to the power outlet. Users may also connect their Snom device directly to a computer using the optional ethernet outlet.

After you have set up the phone and connected it to the network as shown, the phone begins to initialize. Normally the initialization is completely automatic, using DHCP. If your network does not support DHCP, you must obtain the IP address, netmask, IP gateway, and DNS server from your Internet service provider or your network administrator and enter them manually when you are asked to do so on the display.

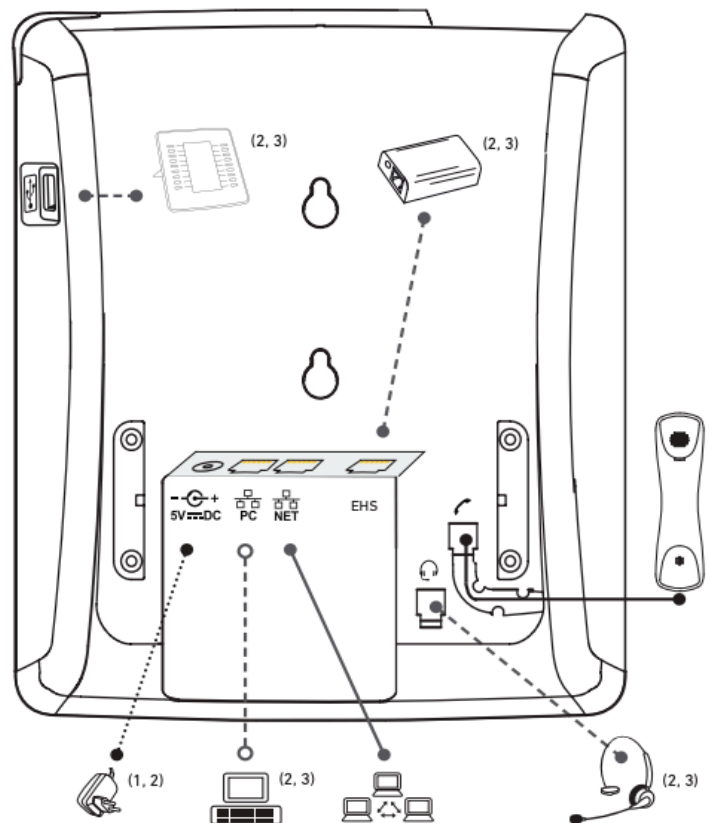

- (1) If PoE not available
- (2) Not included in delivery
- (3) Optional

WHAT TO DO IF REGISTRATION AND INITIALIZATION ARE UNSUCCESSFUL:

Before contacting your system administrator:
Press * * # (asterisk, asterisk, square) on the keypad

Press and hold # to reboot the phone
Keep holding # until Rescue Mode appears on screen

Press 1 for settings reset

Press any key when prompted to reboot. The phone will be successfully reset after start-up

CAUTION: Do not power off during phone start-up

Contact your network system administrator if the phone is operating or supposed to be operating within a network. If you are using a VoIP provider, you may need to enter further data, as specified by your provider.